



**INFORMATION, INSTRUCTION,
INSTALLATION AND
SEVEN YEAR WARRANTY
DOCUMENT**

Patent #: ZA 2007/02408
ZA 2000/4410

Tel: +27 21 872 0900
Fax: +27 21 872 8604
E-mail: info@xstream.co.za
Website: www.xstream.co.za

Distillery Road
Paarl
7646

PO Box 3132
Paarl
7620

Serial Number: _____ Date of manufacture: _____

Congratulations with your purchase of our solar adaptable corrosion free hot water cylinder (HWC).

We have taken great care in manufacturing our product and appreciate your support. We believe our product will give you good service, justifying your trust in our product and Company.

Please contact us should you want to share your experience in buying or installing the product, good or bad. That way we can improve our service to our customers.

Telephone: +27 21 872 0900

Fax: +27 21 872 8604

Email: info@xstream.co.zaWebsite: www.xstream.co.za<https://www.facebook.com/xstream.geysers><https://twitter.com/XstreamSolarHWC>

1. DOCUMENT

This is your **information, instruction, installation and warranty document** all in one for ease of future reference. We have also included a diagram (Document A) of what a correct installation looks like. Please familiarise yourself with the contents as the information contained herein will assist in realising your expectations of our product and service.

We suggest you store it in an easy to reach place, e.g. the inside of your electric distribution board, as a visible reminder to read through it from time to time.

Please follow the installation instructions carefully, and check the final installation according to the instructions. The Xstream MAINSTREAM range can only be installed in a horizontal position and is suitable for in- or outdoor installations.



Warranty conditions will be highlighted as shown.

2. WARRANTY

Important to note by the Homeowner and Installer

Our warranty is subject to correct installations in accordance with SANS 10254 (electric water heaters) and SANS 10106 (solar water heaters). Highlighted warranty conditions are in addition and not separate from the SANS installation codes.

It is a specific condition of this warranty to have proof that the T&P valve (safety valve) is serviced and / or replaced within every two years of the anniversary of the original installation. Specific care should be taken to ensure that no blockages occur on the inside (e.g. due to lime scale built-up), and that the wax layer on the stem of the T&P valve is intact. If any evidence suggests that the safety valve has opened during the period dated from the previous service date, then such safety (T&P valve) must be replaced at the expense of the home owner and the date recorded accordingly. (See at the end of this booklet).

In water conditions where there is any likelihood of lime scale built-up the element must be inspected at the same intervals as the T&P valve mentioned above.

All home owners please ensure you get your Certificate of Compliance from your installer. We suggest you keep it together with your product warranty document.

Please note that Xstream Solar HWC (Pty) Ltd (“Xstream”) is not the installer, nor does Xstream warrant the correct installation – that is the sole responsibility of the Installer.

2.1. What our warranty covers

Our Xstream Mainstream tanks carry a seven year time-reducing warranty* subject to normal and correct installations and usage. The warranty is against faulty materials and/or workmanship in manufacture and is applicable from the date of installation (proof required) alternatively from the date of manufacturing.

The warranty period in respect of the thermostat, element, temperature and pressure relief (safety) valve and drain valve is limited to six months and does not cover any labour.

This warranty covers parts only, and labour will be charged out at rates applicable at the time. Xstream Solar Hot Water Cylinders (Pty) Ltd’s obligations are specifically limited to the foregoing and this warranty expressly covers the Xstream range of water heaters only and does not cover any other parts of the installation which may as a consequence of the failure or defect of Xstream water heaters, become damaged in any way whatsoever and in no circumstances shall Xstream be held liable for any direct or indirect or consequential loss suffered by the customer or any other party.

This warranty is the only warranty which is given and is expressly in lieu of all other warranties, expressed or implied in law, including any implied warranty of merchantability or fitness for a particular purpose. No amendments or additions to this warranty shall be binding on Xstream unless recorded in writing and signed by a duly authorised officer of the company.

This warranty shall be vitiated and rendered of no force and effect if any repairs or any work is undertaken by the customer or others on his behalf in an attempt to remedy an alleged fault unless authorised in writing by the manufacturer.

NB: The warranty is only applicable if the HWC is connected to regional water supply via a pressure reducing valve, expansion relief valve and vacuum breakers and correctly handled by qualified personnel, further that all electrical work to be undertaken by qualified persons only.

*the extent of the cover provided by this warranty is reduced monthly, on the anniversary of the date of purchase, by an amount proportionate to the period of the warranty, e.g. purchase price R1 000.00, cover reduced in month 14 being $(84-14)/84 \times 1\ 000 = R\ 833$ etc.

Xstream Solar HWC (Pty) Ltd may decide either to pay the balance of the warranty out in cash or to have the cylinder repaired or replaced, in which case the warranty will not start afresh as the warranty period will still be calculated from the original installation regardless how many repairs or replacements have been carried out.

3. SOLAR OPTION

3.1. Product adaptability

These units are standard electric but also solar adaptable (direct system). This means solar absorbent panels can be installed at ANY TIME. Our Mainstream Dual range makes provision to have the element installed in the upper half of the tank thereby minimising electrical usage as only half the volume of the tank will be heated using electricity whilst the total volume will be heated using solar energy if connected to solar source.

3.2. Solar Installation

Remember that the cylinder **MUST** be installed at a higher point than the highest point of the solar panel, so that the heated water from the panel can rise to the top of the Xstream tank. (Prevent any potential downward sloped angles as this will stop the solar circulation). The colder water inside the tank will then drop down to the panel in order to be heated by solar radiation to form the continuous solar flow required.

This then is the reason why the solar flow between the Xstream tank and solar panel will stop at night when there is no solar radiation – the coldest (heavy) water molecule will drop to the bottom of the panel and remain there leaving the hottest (lightest) water inside the Xstream storage tank for use on demand.

Orientate the solar panels towards north, plus or minus 20 degrees at a pitch of no less than 25 degrees. Contact our factory for various galvanised frame options. In order to maximise the efficiency on a sloped roof installation ensure that the fittings on the Xstream tank are on the left hand side of the installation.

3.3. Frost areas

You are advised, when the solar option is considered in areas with **freezing conditions** in winter, rather to use our **Solarstream HWC (indirect system, fitted with heat exchanger)**, or **tubes fitted with heat pipe connected to the Mainstream**.

3.4. Forced circulation

Should you wish to install the storage tank at a position lower than the absorption panel, a **circulation pump** of some sort will be required. Please contact our factory for options.

4. THERMOSTAT SETTING AND CORRECT SIZING OF ABSORBERS

When connecting solar panels or tubes to the Mainstream range, we recommend the thermostat to be set at 35°C - 45°C. This will prevent the system from overheating whilst still ensuring hot water, should there be no solar radiation from the sun due to rain or heavy clouds.

In selecting the **absorption area (panel size)**, use 55-75 litre of storage water per square meter of panel, e.g. 200 litre HWC will use a 3m² panel (67 litre / m²), or when vacuum tubes are considered, 10 to 12 litre per tube, e.g. a 200 litre tank 16 to 20 tubes.

Volume	Geyser Size - Litre					Panel Size - m ²				Manifold and Tubes		
	100MS	150MS	150MSD	200MS	200MSD	1.5 m ²	2.0 m ²	2.4 m ²	3.0 m ²	10 Tube	15 Tube	20 Tube
100 Litre	✓					✓				✓		
150 Litre		✓					✓				✓	
200 Litre				✓					✓			✓
300 Litre			✓✓				✓✓				✓✓	
350 Litre			✓		✓			✓✓			✓✓	
400 Litre					✓✓				✓✓			✓✓

We believe that nature is in balance, and we need to respect that by not overheating the systems due to oversupply of absorption areas which will damage plumbing lines, tap washers, increase the risk of scaling etc. over time.

4.1. Explanation: *When the system reaches a temperature of 93 °C the safety valve (also known as “T&P valve”) fitted on the Xstream tank should open up, relieving pressure and heat. (“T” indicates “Temperature above 93 °C and “P” indicates “Pressure Overload” - above 600 kPa). When the safety vales open up, hot water will run from the tank whilst the incoming cold water will then stabilize the water temperature and pressure inside the tank. This cycle will unfortunately be repeated if incorrectly sized, or thermostat setting being too high.*

The safety valve should be replaced once this has happened and the installation be corrected to prevent it from happening again in future.







Please ensure proper insulation (R1) is installed on all exposed pipework.

5. **OTHER WARRANTY CONDITIONS**

- We supply our tanks with pre-fitted copper-to-copper compression fittings for ease of installation. No soldering is allowed. **Do not remove the supplied fittings from the storage tank.**
- All components used or replaced must be SABS approved. Components include 400 kPa Pressure control valve, 2 x vacuum breakers, drain valve, element, thermostat, fittings and 400 kPa safety valve – the safety valve requires servicing every two years.
- Xstream tanks operate on any pressure up to 400 kPa and a suitable Pressure control valve must be fitted. According to IEC 335-2-21 the discharge pipe from the pressure relief valve must be left open to atmosphere because water may drip from it.
- According to IEC 335-2-21, the pressure relief device is to be operated regularly to remove lime deposits and to verify that it is not blocked.
- According to IEC 33-2-21, a discharge pipe connected to the pressure relief device is to be installed in a continuous downward direction and should be in a frost-free ambient.
- A suitable isolator with at least 3mm contact separation must be incorporated in the fixed wiring within 1 meter of the Xstream HWC.
- The safety valve (T&P-valve) is factory fitted onto the HWC and must never be removed.

6. INSTALLATION

6.1. Interior Installation

- Position the drip tray, sloping towards the outlet in a secured position.
- Place the Xstream HWC inside the drip tray, ensuring that the fittings are inside the drip tray.
-  Allow 800mm free space for the element to be replaced if necessary in future.
- If a solar panel is not connected, block the solar in- and outlet to be opened at any future time when a panel is to be connected.
- Connect the incoming cold line to the inlet (at bottom of HWC). Ensure a proper anti-syphon loop is installed. Use a suitable male inlet coupler (MIC).
 -  All fittings onto the Xstream HWC are factory fitted and must not be removed as this will render the warranty null and void.
 -  Ensure that a suitable (up to 400kPa) pressure reducing valve (PRV) is connected to the incoming line and that the cold supply is taken from a point after the PRV. This will ensure balanced pressure (Hot and cold water supply at a mixing tap having the same pressure).
 -  Install a vacuum breaker at least 300mm above the HWC on the incoming cold line.
 -  Connect the hot water supply line from the outlet, also installing a vacuum breaker, as per cold inlet procedure.
- Please ensure copper tube is used on the hot water supply line.
- Connect copper tube (must be 22 mm) to the temperature and pressure safety valve (T&P) and take it at a downward slope to the outside, away from areas where it can cause scaling. Try to minimise sharp bends.
- The T&P valve can be adjusted to the required angle. Loosen the securing nut, adjust the angle and fasten the nut at the desired angle.
- Fill the HWC with water. Leave a hot water tap open to get any extra air out of the system.
- Once filled, close the tap.
- Proceed by connecting the electrical supply. Ensure a suitable qualified artisan performs this function. Open the electrical box and connect the electricity line. Always ensure the electricity line is dead when working with electricity.
- Install a suitable isolator switch within easy reach of the HWC.
-  Always ensure that the HWC is filled with water BEFORE the electrical supply is commissioned. Failing this the HWC and submersible element might be damaged, and warranty will be null and void.
-  Check all fittings for leaks, and ensure all supply lines are properly fastened and secured to fastening points; thereby minimizing strain on the fittings attached to the HWC. All pipe connections to the Xstream HWC must be properly supported.

6.2. Exterior Installation

- All procedures as per interior installation, however, instead of using the drip tray use the stainless steel straps, available on request.
- Use a spirit level and mark the points where the straps are to be positioned – allow 300mm from both ends of the HWC, for tank sizes up to 150 litre. Our 200 litre tank requires 3 straps, with the third strap positioned in the centre.
- Use at least 10 x 100 mm suitable anchoring bolts for wall installations, or other suitable securing bolts for roof installations.
- Properly secure the straps.
- Push the HWC through the loops and proceed with connecting procedures as described.

6.2.1. If connected to solar absorption panel (SP), proceed as follows:

- Position the SP onto the roof, facing north. Follow the instructions from the SP manufacturer to ensure a secured installation. Ensure that the SP is level by using a spirit level.
- Position the Mainstream HWC above the SP with the fittings (on the HWC), when the SP is facing from the front, to **the left of the SP**. Ensure that the HWC is level.
- Connect the SP to the HWC as follows:
 - From the top of the SP to the top of the HWC, marked “From top of panel”. Make sure there are no negative (downward) bends.
 - From the bottom of the HWC (marked “to the bottom of panel”) to the bottom of panel.
- It is advisable to connect it to the opposite bottom position on the SP, or if vacuum tubes with a manifold is used to the opposite end. Ensure that a negative flow is created by forming a “gooseneck”, taking the solar return to a point below the manifold and then up again.
- On our Mainstream Dual tank the rear 22 mm fitting can be used as indicated for “solar from top of panel” connection minimising pipe work.
- Follow instructions as per interior installation above pertaining to the tank installation.
- Please ensure correct thermostat setting.

6.2.2. Split system Installations

- If forced circulation is required (where the HWC is positioned at a point lower than the SP) follow the instructions of the pump supplier.
- Always ensure that the water is circulated FROM the tank (HWC) TO the panel (SP). This will ensure that the cooler water is circulated through the pump.



7. MAINTENANCE INSTRUCTIONS

7.1. ELEMENT REPLACEMENT and/ or element inspection.

1. Switch electricity off.
2. Close cold water supply valve.
3. Drain water from HWC.
4. The valve on the T&P may be opened to allow air into the system to facilitate draining.
5. Disconnect supply wires at thermostat.
6. Remove thermostat.
7. Remove earth connection on element.
8. Unscrew element nut with an element spanner, remove element.
9. Inspect the element and replace if necessary.
10. Reverse procedure for recommissioning.

7.2. THERMOSTAT REPLACEMENT

1. Switch off electricity.
2. Disconnect supply wires to thermostat.
3. Remove the thermostat by pulling it out of the element pocket.
4. Push new thermostat into the pocket and ensure that the lugs are properly aligned.
5. Push in the thermostat fully.
6. Set thermostat between 55-60°C for a non-solar installation.
7. Set thermostat between 35-45°C for solar installation.

8. Please contact our Service Desk on +27 21 872 0900, info@xstream.co.za if any further assistance is required or you need to log a fault on your Xstream tank.

9. SERVICE RECORD:

Date	Service provider	Action
-----	-----	-----
-----	-----	-----
-----	-----	-----
-----	-----	-----
-----	-----	-----

**THIS WARRANTY IS VALID WITHIN THE BORDERS OF SOUTH AFRICA.
ENJOY THE HOT WATER SUPPLIED BY YOUR NEW XSTREAM
MAINSTREAM, SOLAR ADAPTABLE, CORROSION FREE HOT WATER CYLINDER!**



Sketch descriptions:

- 1) 25 A Circuit Breaker.
- 2) Electrical supply must be connected by a qualified electrician.
- 3) Double pole isolator switch within 1m from electric hot water cylinder.
- 4) Electrical box/ Element housing IPX4 rated.
- 5) Cold water inlet from main.
- 6) 400 kPa Pressure Reducing Valve.
- 7) Balanced Pressure cold water feed.
- 8) Anti syphon loop: inlet above highest point of geyser.
- 9) Vacuum Breaker 300 mm above geyser on cold inlet.
- 10) Vacuum Breaker 300 mm above geyser on hot outlet.
- 11) Hot water outlet from tank.
- 12) Solar port (Plug with stopper if not solar connected.)
- 13) Temperature & Pressure (Safety) Valve, copper pipe connected. Always to slope downwards.
- 14) Cold inlet / drain valve.
- 15) Solar port (Plug with stopper if not solar connected.)
- 16) Drip tray outlet towards outside (ensure downward slope.)
- 17) Xstream Drip Tray.

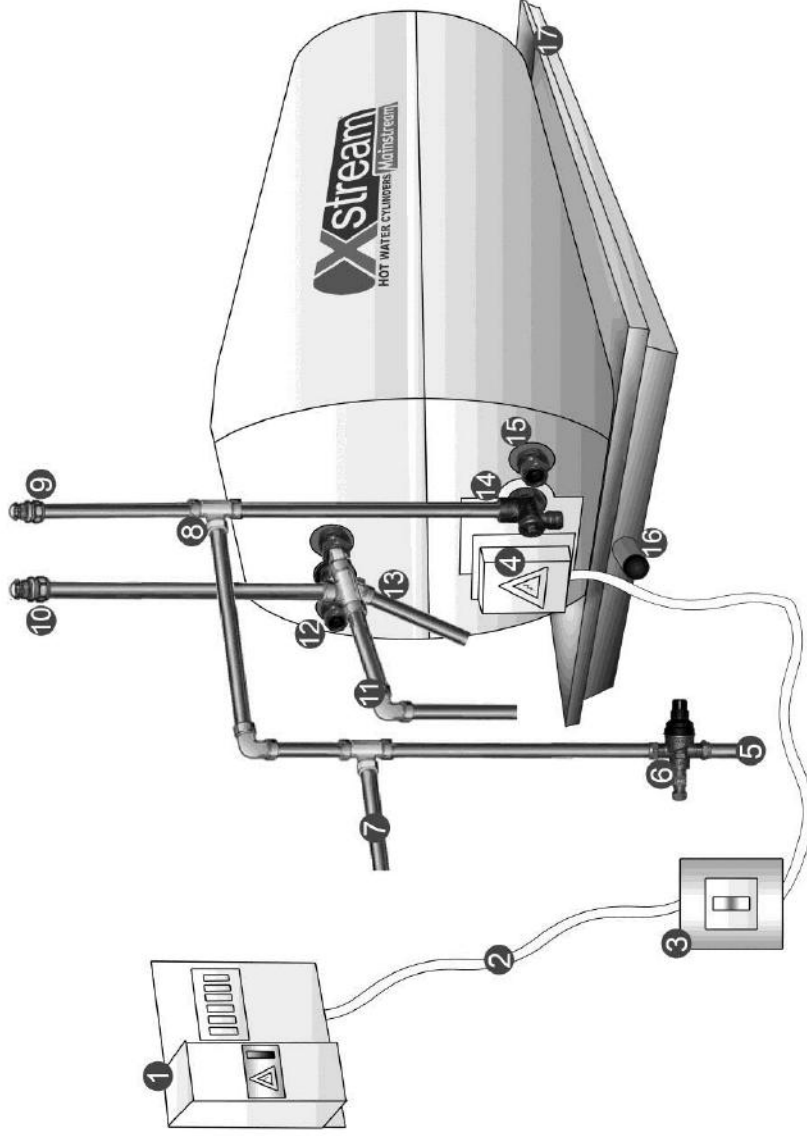

SPECIFICATION
AS PER SANS 10254- INSTALLATION





Interconnection:
300 Litre system (2 x 150 Litre tanks)
or
400 Litre system (2 x 200 Litre tanks)

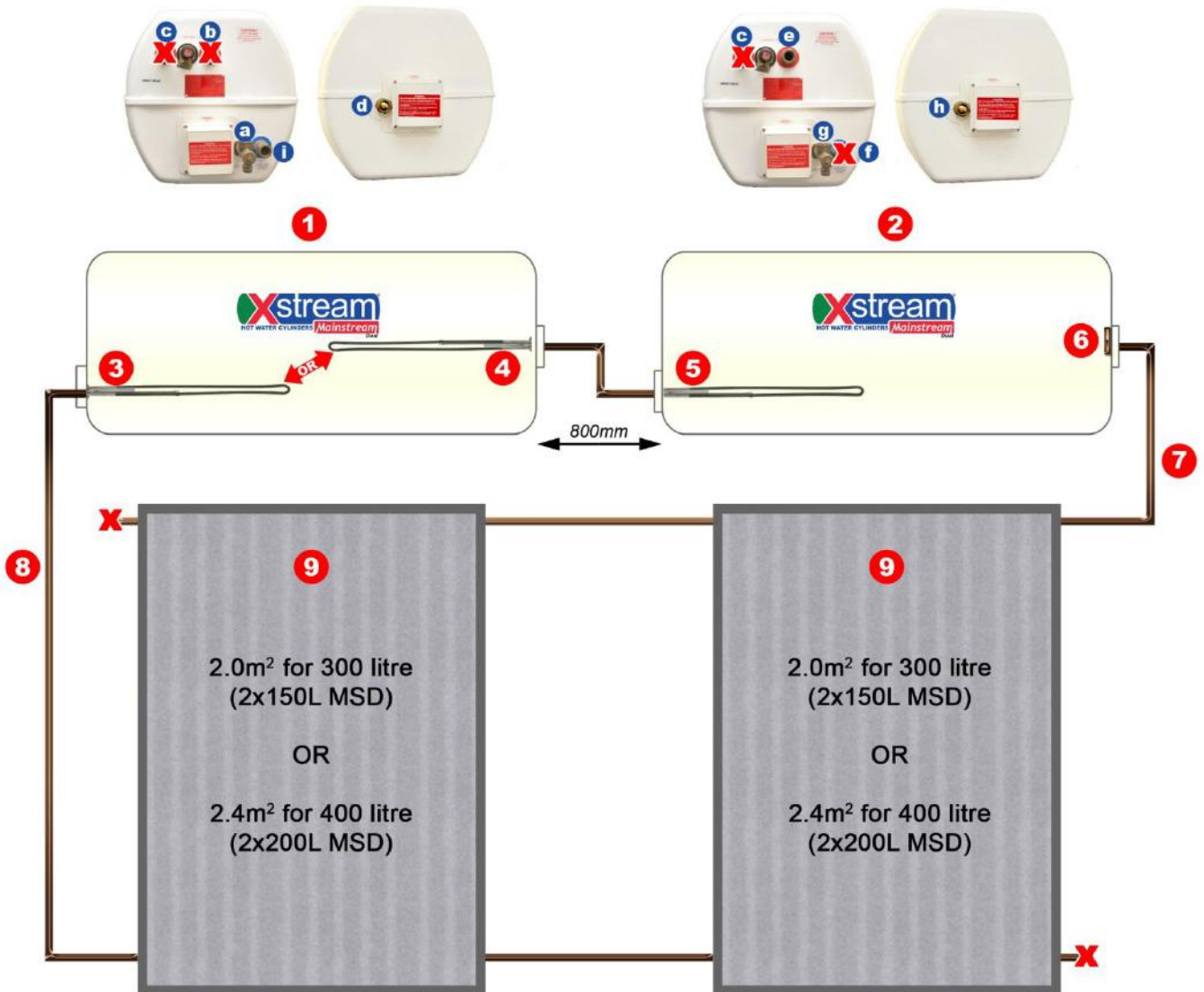

1. 150L Mainstream Dual

- Cold inlet (a)
- Block hot water outlet (b)
- Block solar from top of panel (c) and to bottom of panel (f)
- Use rear port (d) to feed into cold inlet geyser 2 (g)

2. 150L Mainstream Dual

- Hot water feed to house (e)
- Block solar from top of panel (c)

3. 3 kW Element - Set at 60°C

4. 3 kW Element - Set at 60°C

5. 3 kW Element - Set at 45°C

6. Fit Element stopper

7. Hot outlet from panel into geyser 2 (h)

8. Cold feed to panel from geyser 1 (i)

9. Interconnected Solar Collector

For technical support contact:

Dawie Thirion

021 872 0900

dawie@xstream.co.za